Hands-On Modal Testing & Analysis Seminar (2023)

(Feb 20-23 | May 22-25 | Aug 14-17 | Aug 21-24 | Nov 13 – 16 | Dec 11 – 14)

Navcon's Hands-On Modal Testing & Analysis Seminar is the only training of its kind; it is truly "Hands-On". We have been presenting this seminar since 1991 and will start 2023 having more than 1250 attendees over the past 32 years. The course focuses upon the practical aspects of modal testing including test planning, data acquisition, data reduction, parameter estimation FEM-Test correlation and results presentation. Lectures are presented from an experimentalist's point of view. Attendees are paired in groups of two. Each group is provided a data acquisition system, test instrumentation and test structures. They conduct their own tests, reduce and assess their own data.

Attendees are encouraged to bring their own notebook computer with them to use during the laboratory exercises. Each attendee will receive a fully functional, 30-day license of **MEscope™** & **FEMtools™**. The software can be used to repeat the seminar laboratory exercises or to conduct Modal and ODS tests and analyses upon returning to their company.

Intended Audience: This intensive four-day course has been designed for engineers and technicians who are tasked with modal data acquisition, data reduction, FEM-Test correlation and troubleshooting noise and vibration problems. The course is structured to be of benefit to both beginners and the more experienced engineers and technicians. The class is often attended by FE analysts who want to know more about the data provided them by the test engineer and about the FEM-Test correlation and FEM updating process. Project Managers who direct modal/GVT projects will also find this training useful.

Course Objective: It is our objective that when attendees complete the Hands-On Modal Testing Seminar, they will be able to plan and conduct Modal Tests, Ground Vibration Tests and Operational Deflection Shape tests on their own.

Presenter: Jim Steedman, president of Navcon Engineering, has been conducting modal, GVT and ODS tests since 1977. Applications include FEM-Test correlation, troubleshooting and health monitoring. He received his bachelor's and master's degrees from the University of Cincinnati where he concentrated on modal testing, structural dynamics modification and acoustic intensity. Jim has traveled worldwide consulting and presenting courses on acoustic intensity, environmental noise, modal testing and noise & vibration control.

Registration: Advanced registration is required. You can register online or complete and return the enclosed registration form. The registration form can be downloaded from our web site ([www - link](#)). Each seminar is limited to 10-attendees and most seminars sell-out. Early registration is recommended, please contact us if you have any questions.

Course Fee: **\$3,200** per attendee. The course fee includes participation, a 300+ page seminar manual, lunches and refreshments. Dinner is also provided on Wednesday night prior to the Porsche modal test. A full refund will be made for all cancellations received 30 days before the start of the course. Substitute attendees will be accepted at any time. In the event that we have to cancel the course, the course fee will be refunded in full, but we disclaim any further liability.

Hands-On Modal Testing & Analysis Seminar – Course Outline

(Feb 20-23, 2023 | May 22-25, 2023 | Aug 14-17, 2023 | Aug 21-24, 2023 | Nov 13 – 16, 2023)

Fourier Analysis (Lecture + Lab)

- Fourier Integral
- Fourier Series
- Time-Frequency Domain Relationships
- Harmonic motion

Digital Signal Processing (Lecture + Lab)

- Analog to Digital Converters
- Sampling Parameters
- Aliasing
- Leakage & Windowing

Measurements (Lecture + Lab)

- Linear System Relationships
- Mathematical Relationships
- Frequency Response & Coherence
- Input, Output & Cross Power
- Time Domain Measurements

Introduction to Modal (Lecture)

- Modal Definitions
- Layman's Visualization
- Lumped, Continuous & Finite Element Models
- Normal Mode vs. Frequency Response Method
- Modal Parameters & Estimation Methods

Single Degree of Freedom Systems (Lecture)

- Characteristic Equation
- Frequency Response Derivation
- Transfer Function on the S-plane
- Transfer Function in Partial Fraction Form
- Mass, Stiffness and Damping sensitivity

Modal Theory (Lecture)

- Analytical Approach
- Test Approach

Excitation Techniques (Lecture + Lab)

- Single & Multiple Shaker Techniques
- Impact Excitation Method
- Acoustic Excitation Method
- Excitation Signal Types

Modal Preparation & Measurements (Lecture)

- Modal Test Overview
- Pretest Considerations
- Detailed Test Procedures
- Computer Models & Visualization
- Understanding Modal Measurements

Modal Theory(Lecture)

- Analytical Approach
- Test Approach

Modal Parameter Estimation (Lecture + Lab)

- SDOF & MDOF Estimators
- Time & Frequency Domain Estimators
- Local & Global Estimators

Operating Deflection Shapes (Lecture + Lab)

- Time Domain ODS
- Frequency Domain ODS

Syructural Dynamic Modification (Lab)

- Test JimBeam, Test Modified JimBeam
- Use SDM to Model Modifications & Compare

Laboratory Exercises

- Signal Processing (Time & Frequency)
- Impact Testing Methods
- Shaker Excitation Techniques
- Modal Test – JimBeam (Impact & Shaker)
- Modal Test – Race Prepared Porsche
- ODS – Time & Frequency Domain
- Create JimBeam FEM, Conduct Pretest Analysis, Conduct Modal Test, Perform FEM-Test Analysis, Update FEM to Match Test Results Using Automated Methods

SEMINAR LABORATORIES:

JimBeam Modal Laboratory: Attendees will (1) create a finite element model of "JimBeam", (2) conduct a modal pretest analysis to identify the optimal excitation & response locations, (3) conduct an impact modal test of JimBeam, (4) correlate the FEM and Test results and (5) update the FEM to match the test data. Other JimBeam laboratories include hammer excitation, pretest DPMR & CPFR measurement surveys and accelerometer mass loading.

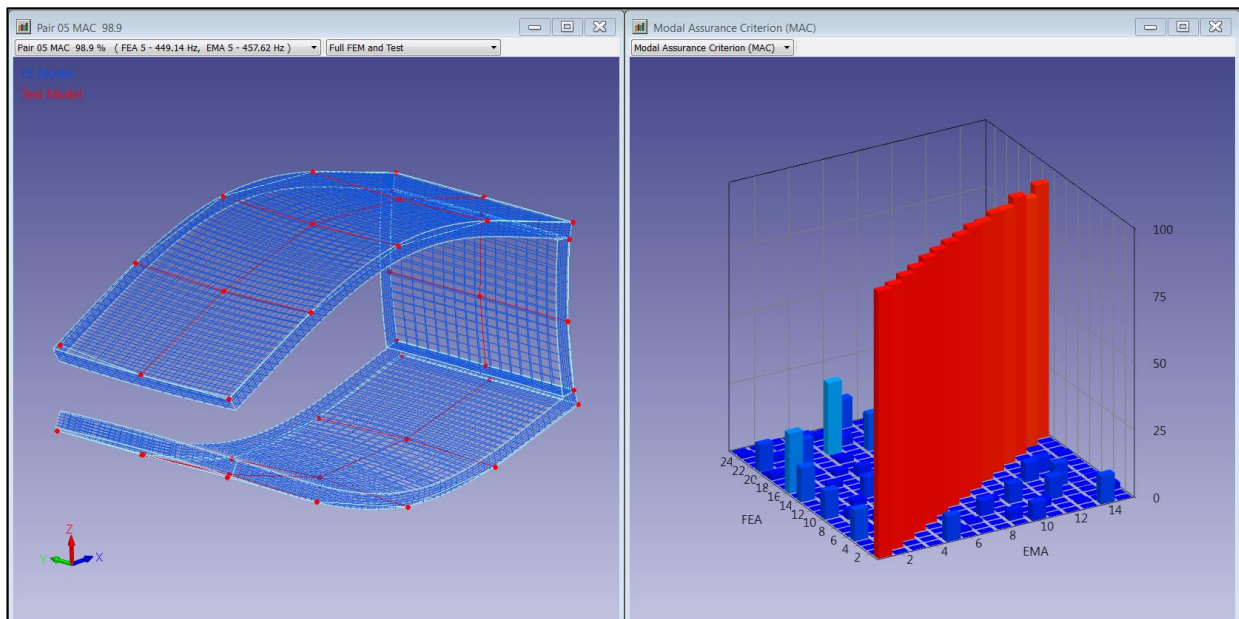

JimBeam Shaker Laboratory: Attendees will setup an electro-dynamic shaker and excite JimBeam using a variety of waveforms including random, pseudo random, burst random, chirp, swept sine, etc. They will compare the input force in the time and frequency domains, frequency response and coherence functions. They will also evaluate system linearity and its effect on the resonant frequencies and damping values.

Porsche Modal Laboratory: Attendees will conduct a shaker modal test on a fully race prepared Porsche (911 or 916). They'll setup the model geometry, acquire the modal measurements and animate the mode shapes. The test ends with a sine dwell test exciting the Porsche at its resonant frequencies. Students compare the vehicle's mode shapes with the forced vibration response.

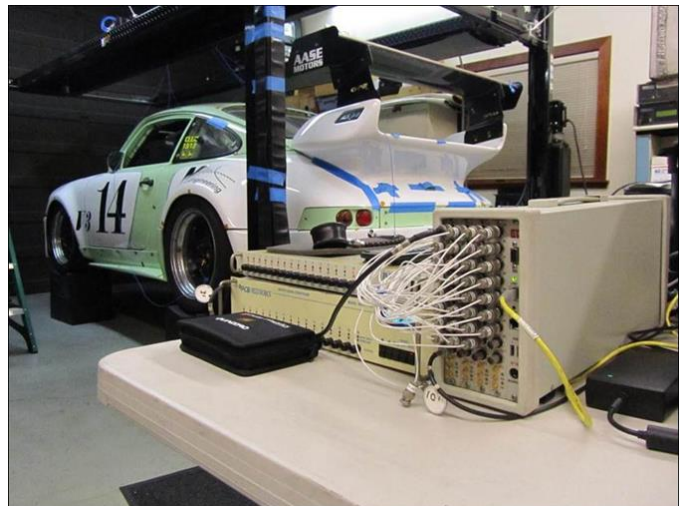
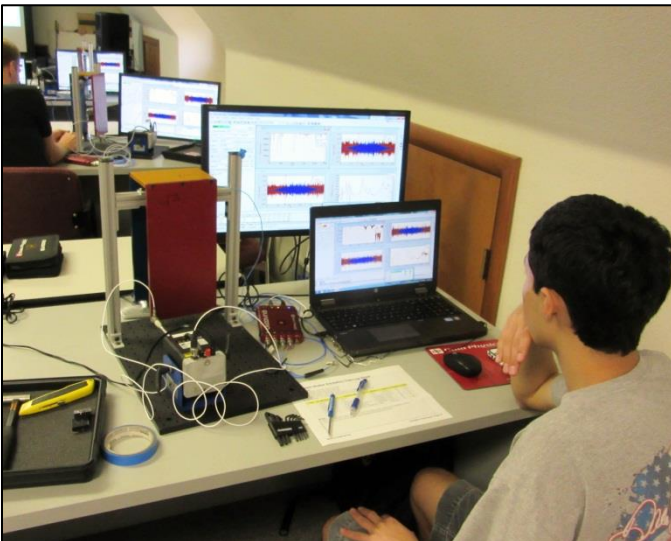
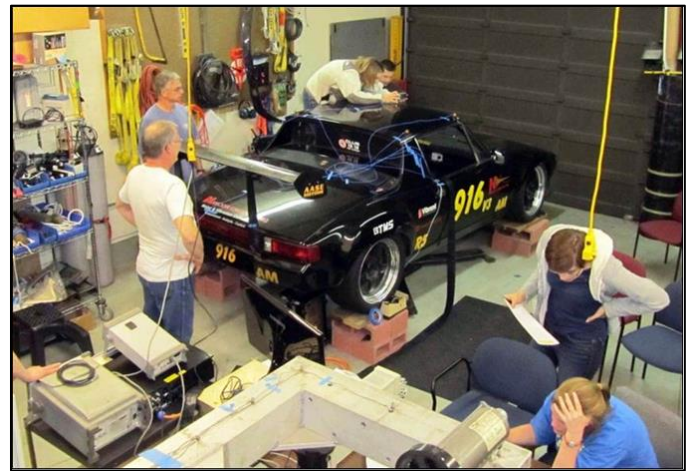
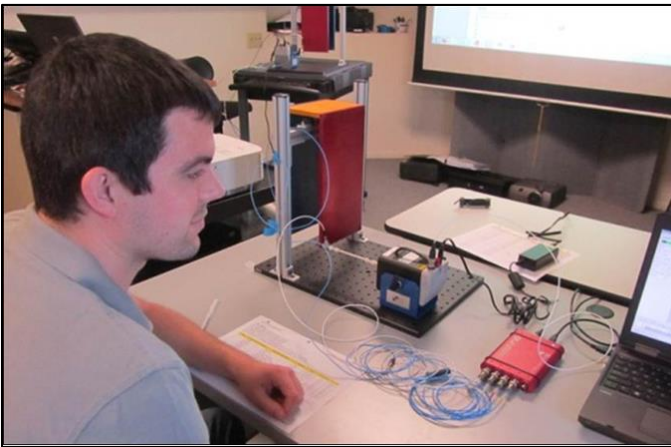

Operational Deflection Shapes Laboratory:

A shaker modal test will be conducted on Navcon's box frame to identify the resonant frequencies and mode shapes. Next the frame will be excited with an electric motor and time domain, frequency domain and ODS-FRF deflection shapes computed. Video-ODS animations will be created using a handheld iPhone. Other box frame labs include linear spectrum averaging, modal pretest analysis and FEM-Test model correlation.

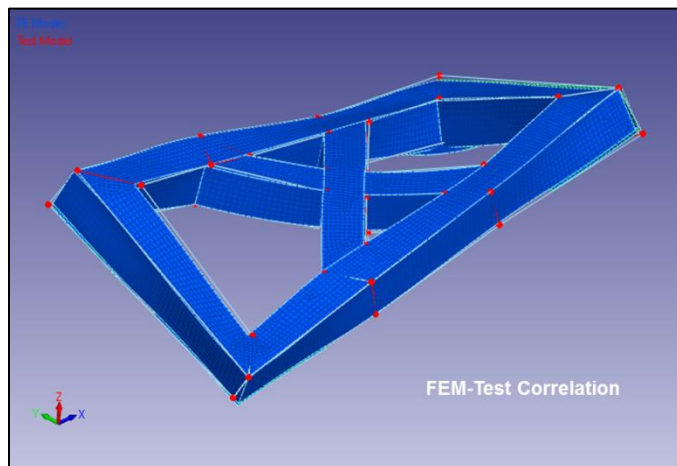

Structural Dynamics Modification (SDM)

Laboratory: SDM is a tool used by both test and simulation engineers to quickly evaluate the effects of making physical changes to a structure. Attendees (1) conduct an impact modal test on JimBeam, (2) add masses or stiffeners to JimBeam and test the physically modified system, (3) they model the physical changes using SDM and (4) compare the SDM & test frequencies, damping and mode shapes.

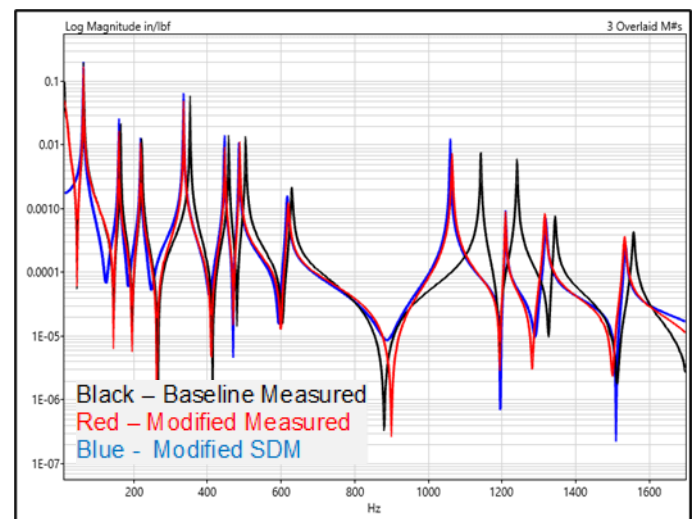
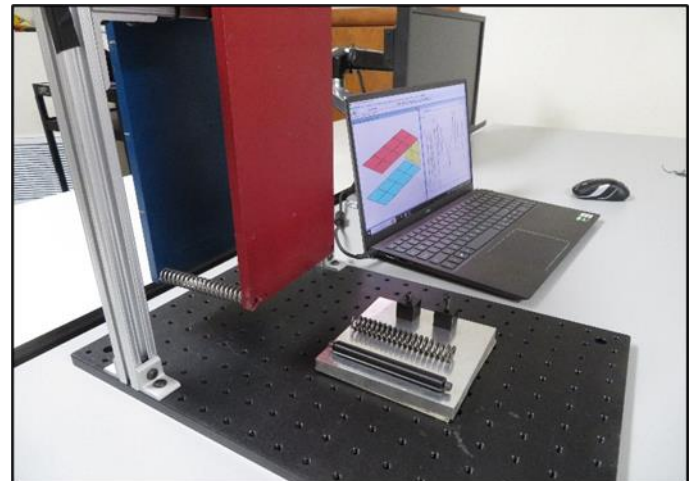

Hands-On Modal Testing & Analysis Seminar (2023) – Course Registration Form

(Feb 20-23 | May 22-25 | Aug 14-17 | Aug 21-24 | Nov 13 – 16 | Dec 11 – 14, 2023)

Name(s)			
Company			
Address			
City, State, Zip			
E-Mail			
Phone	Fax		
Date	Signature		
Class Date	Feb 20-23, 2023 <input type="checkbox"/>	May 22-25, 2023 <input type="checkbox"/>	Aug 14-17, 2023 <input type="checkbox"/>
	Aug 21-24, 2023 <input type="checkbox"/>	Nov 13 - 16, 2023 <input type="checkbox"/>	Dec 11 - 14, 2023 <input type="checkbox"/>
Payment	P.O. No. Company Check <input type="checkbox"/> Payment: US \$3,200.00		
	Bank Transfer <input type="checkbox"/> Credit Card: Visa <input type="checkbox"/> MasterCard <input type="checkbox"/>		
	Credit Card #: _____ Expiration Date: ____ / ____		
	Name on Credit Card: _____		
	Billing Zip Code: _____		
Card Verification Value CVV #: _____ (3 digits on the back)			

The course fee is **\$3200** per attendee. We accept company purchase orders with terms of Net 30 days, company checks, money orders, bank transfers and credit card (Visa, MasterCard). If we must cancel the course, the course fee will be refunded in full, but we disclaim any further liability. The course fee includes participation, course notes, lunches, refreshments and dinner on the second night before the Porsche modal test. We offer vegetarian options and we will try to accommodate other dietary requests; please let us know in advance. The training room has stairway access only (no elevator or escalator access). For administrative & technical questions please call 714-441-3488 or email to webinfo@navcon.com. The Hands-On Modal Testing & Analysis typically sells out. We will add training dates throughout the year as necessary. Please register early.

Note: Updated schedule and added modal seminars Aug 21-24 and Dec 11-14.