Hands-On Modal Testing & Analysis Seminar

(Jan 25-28, 2022 | May 3-6, 2022 | Aug 9-12, 2022 | Nov 1-4, 2022)

Navcon's Hands-On Modal Testing & Analysis Seminar is the only training of its kind offered in either United States or Europe; it is truly "Hands-On". We have been presenting this seminar since 1991 and will start 2022 having 1203 attendees over the past 31 years. The course focuses upon the practical aspects of modal testing including test planning, data acquisition, data reduction, parameter estimation FEM-Test correlation and results presentation. Lectures are presented from an experimentalist's point of view. Attendees are paired in groups of two. Each group is provided a data acquisition system, test instrumentation and test structures. They conduct their own tests, reduce and assess their own data.

Attendees are encouraged to bring their own notebook computer with them for use during the laboratory exercises. We will load a fully functional copy of **MEscope™** & **FEMtools™** on the notebooks which will operate for 30 days. The software can be used to repeat the seminar laboratory exercises or to conduct Modal and ODS tests and analyses upon returning to their company.

Intended Audience: This intensive four-day course has been designed for engineers and technicians who are tasked with modal data acquisition, data reduction, FEM-Test correlation and troubleshooting noise and vibration problems. The course is structured to be of benefit to both beginners and the more experienced engineers and technicians. The class is often attended by FE analysts who want to know more about the data provided them by the test engineer and about the FEM-Test correlation and FEM updating process. Project Managers who direct modal/GVT projects will also find this training useful.

Course Objective: It is our objective that when attendees complete the Hands-On Modal Testng Seminar, they will be able to plan and conduct Modal Tests, Ground Vibration Tests and Operational Deflection Shape tests on their own.

Presenter: Jim Steedman, president of Navcon Engineering, has been conducting modal, GVT and ODS tests since 1977. Applications include FEM-Test correlation, troubleshooting and health monitoring. He received his bachelor's and master's degrees from the University of Cincinnati where he concentrated on modal testing, structural dynamics modification and acoustic intensity. Jim has traveled worldwide consulting and presenting courses on acoustic intensity, environmental noise, modal testing and noise & vibration control.

Registration: Advanced registration is required. You can register online or complete and return the enclosed registration form. The registration form can be downloaded from our web site (<http://www.navcon.com/HandsOnModal.htm>). The number of participants is limited and early registration is recommended.

Course Fee: **\$2,950** per attendee. The course fee includes participation, a 300+ page seminar manual, lunches and refreshments. Dinner is also provided on Wednesday night prior to the Porsche modal test. A full refund will be made for all cancellations received 60 days before the start of the course. Substitute attendees will be accepted at any time. In the event that we have to cancel the course, the course fee will be refunded in full, but we disclaim any further liability.

Hands-On Modal Testing & Analysis Seminar – Course Outline

(Jan 25-28, 2022 | May 3-6, 2022 | Aug 9-12, 2022 | Nov 1-4, 2022)

Fourier Analysis (Lecture + Lab)

- Fourier Integral
- Fourier Series
- Time-Frequency Domain Relationships
- Harmonic motion

Digital Signal Processing (Lecture + Lab)

- Analog to Digital Converters
- Sampling Parameters
- Aliasing
- Leakage & Windowing

Measurements (Lecture + Lab)

- Linear System Relationships
- Mathematical Relationships
- Frequency Response & Coherence
- Input, Output & Cross Power
- Time Domain Measurements

Introduction to Modal (Lecture)

- Modal Definitions
- Layman's Visualization
- Lumped, Continuous & Finite Element Models
- Normal Mode vs. Frequency Response Method
- Modal Parameters & Estimation Methods

Single Degree of Freedom Systems (Lecture)

- Characteristic Equation
- Frequency Response Derivation
- Transfer Function on the S-plane
- Transfer Function in Partial Fraction Form
- Mass, Stiffness and Damping sensitivity

Modal Theory (Lecture)

- Analytical Approach
- Test Approach

Excitation Techniques (Lecture + Lab)

- Single & Multiple Shaker Techniques
- Impact Excitation Method
- Acoustic Excitation Method
- Excitation Signal Types

Modal Preparation & Measurements (Lecture)

- Modal Test Overview
- Pretest Considerations
- Detailed Test Procedures
- Computer Models & Visualization
- Understanding Modal Measurements

Modal Theory(Lecture)

- Analytical Approach
- Test Approach

Modal Parameter Estimation (Lecture + Lab)

- SDOF & MDOF Estimators
- Time & Frequency Domain Estimators
- Local & Global Estimators

Operating Deflection Shapes (Lecture + Lab)

- Time Domain ODS
- Frequency Domain ODS

Laser Vibrometry (Lecture + Lab)

- Full Field Scanning Laser Vibrometry
- Single Point Measurements

Laboratory Exercises

- Signal Processing (Time & Frequency)
- Impact Testing Methods
- Shaker Excitation Techniques
- Modal Test – JimBeam (Impact & Shaker)
- Modal Test – Race Prepared Porsche
- ODS – Time & Frequency Domain
- Create JimBeam FEM, Conduct Pretest Analysis, Conduct Modal Test, Perform FEM-Test Analysis, Update FEM to Match Test Results Using Automated Methods

SEMINAR LABORATORIES:

JimBeam Modal Laboratory: Attendees will (1) create a finite element model of "JimBeam", (2) conduct a modal pretest analysis to identify the optimal excitation & response locations, (3) conduct an impact modal test of JimBeam, (4) correlate the FEM and Test results and (5) update the FEM to match the test data. Other JimBeam laboratories include hammer excitation, pretest DPMR & CPFR measurement surveys and accelerometer mass loading.

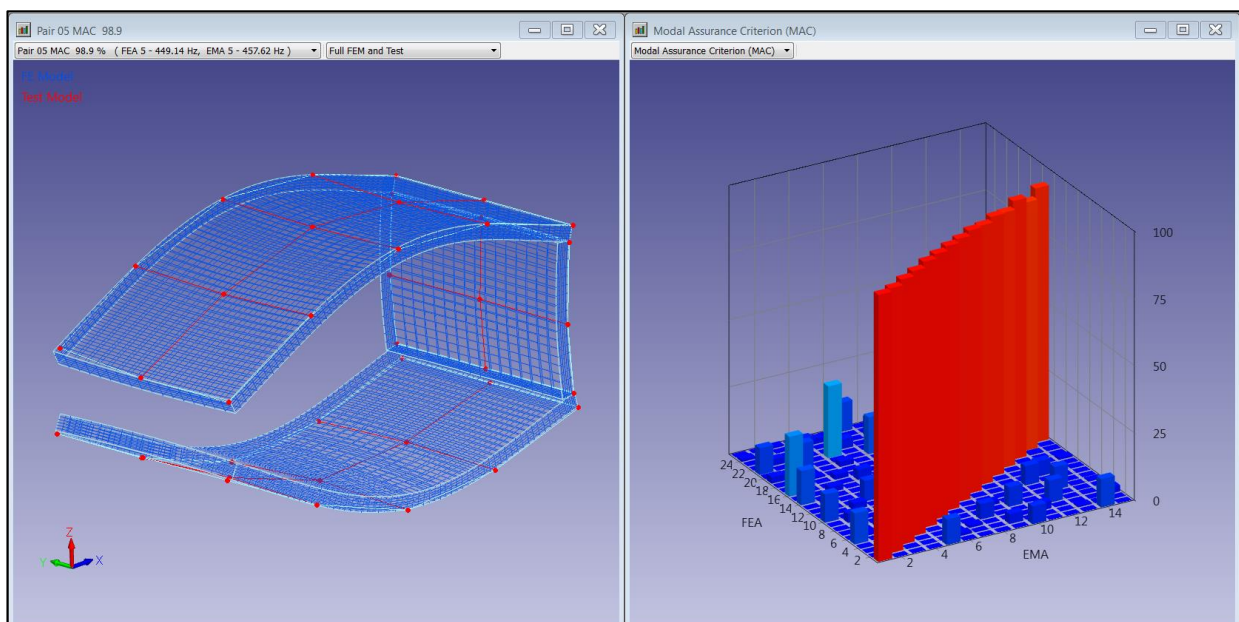

JimBeam Shaker Laboratory: Attendees will setup an electro-dynamic shaker and excite JimBeam using a variety of waveforms including random, pseudo random, burst random, chirp, swept sine, etc. They will compare the input force in the time and frequency domains, frequency response and coherence functions. They will also evaluate system linearity and its effect on the resonant frequencies and damping values.

Porsche Modal Laboratory: Attendees will conduct a shaker modal test on a fully race prepared Porsche (911 or 916). They'll setup the model geometry, acquire the modal measurements and animate the mode shapes. The test ends with a sine dwell test exciting the Porsche at its resonant frequencies. Students compare the vehicle's mode shapes with the forced vibration response.

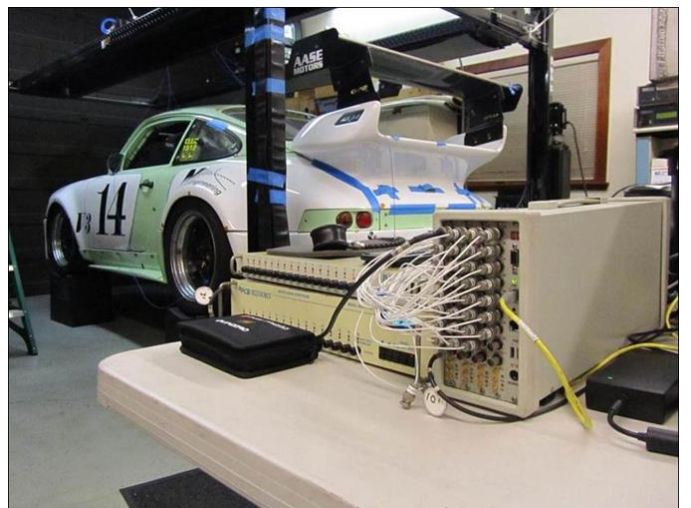
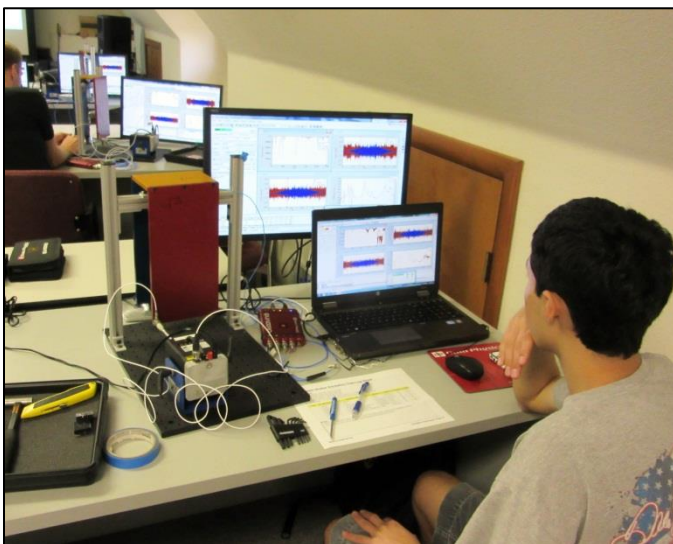
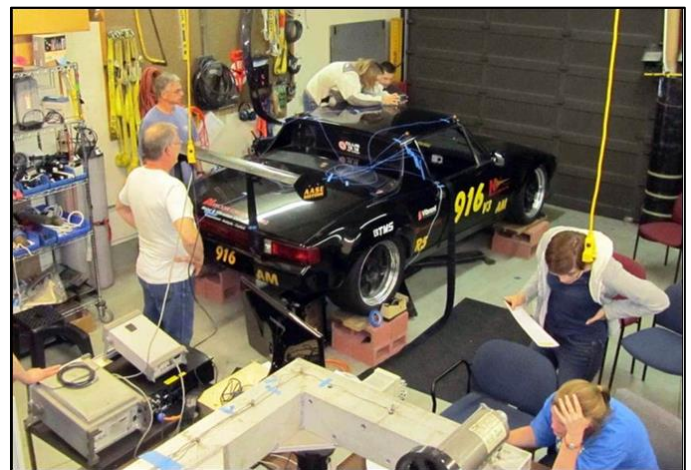
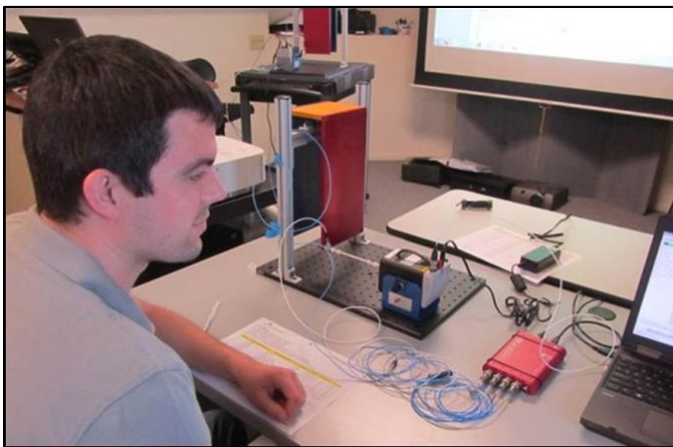

Operational Deflection Shapes Laboratory:

A modal test will be conducted on Navcon's box frame to identify the resonant frequencies and mode shapes. Next the frame will be excited with an electric motor and both time domain and Frequency domain operational deflection shapes computed and animated. Finally, the operational response will be characterized using the FRF-ODS method. Other labs include linear spectrum averaging, pretest analysis and FEM-Test model correlation.

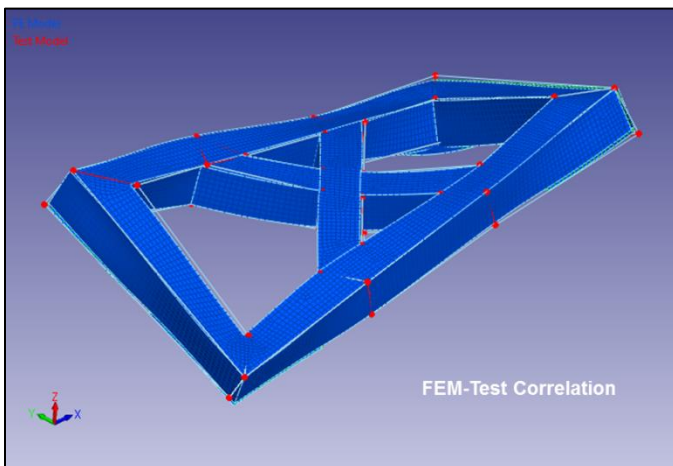

Polytec Laser Laboratory:

Well start out with a brief technical discussion of laser vibrometry instrumentation and applications. Each group will then operate their own Polytec Laser Vibrometer, evaluate accelerometer mass loading and conduct a modal test on JimBeam. There will also be Polytec scanning laser vibrometer demonstration including operational deflection shapes and "quick" scans..

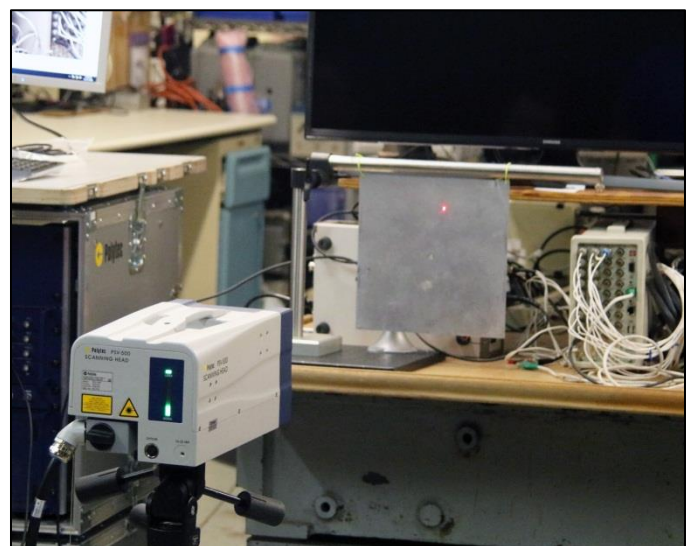

Hands-On Modal Testing & Analysis – Course Registration Form

(Jan 25-28, 2022 | May 3-6, 2022 | Aug 9-12, 2022 | Nov 1-4, 2022)

Name(s)
Company
Address
City, State, Zip
E-Mail
Phone Fax
Date Signature
Class Date	Jan 25-28, 2022 <input type="checkbox"/> May 3-6, 2022 <input type="checkbox"/> Aug 9-12, 2022 <input type="checkbox"/>
	Nov 1-4, 2022 <input type="checkbox"/> <input type="checkbox"/> <input type="checkbox"/>
Payment	P.O. No. Company Check <input type="checkbox"/> Payment: US \$2,950.00 Bank Transfer <input type="checkbox"/> Credit Card: Visa <input type="checkbox"/> MasterCard <input type="checkbox"/> Credit Card #: _____ Expiration Date: _____ / _____ Name on Credit Card: _____ Billing Zip Code: _____ Card Verification Value CVV #: _____ (3 digits on the back)

The course fee is \$2950 per attendee. We accept company purchase orders with terms of Net 30 days, company checks, money orders, bank transfers and credit card (Visa, MasterCard). A full refund will be made for all cancellations received 60 days before the start of the course. If we must cancel the course, the course fee will be refunded in full, but we disclaim any further liability. The course fee includes participation, course notes, lunches, refreshments and dinner on the second night before the Porsche modal test. We offer vegetarian options and we will try to accommodate other dietary requests; please let us know in advance. The training room has stairway access only (no elevator or escalator access). For administrative & technical questions please call 714-441-3488. To register, fax Pg. 6 to +1-714-441-3487 or email to webinfo@navcon.com. The Hands-On Modal Testing & Analysis typically sells out. We will add training dates throughout the year as necessary. Please register early.